

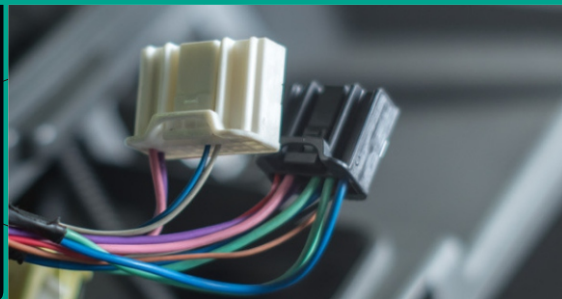

Automotive Connector Series

汽车连接器系列

连接产品 · 精工之选





0.5mm Series Connector

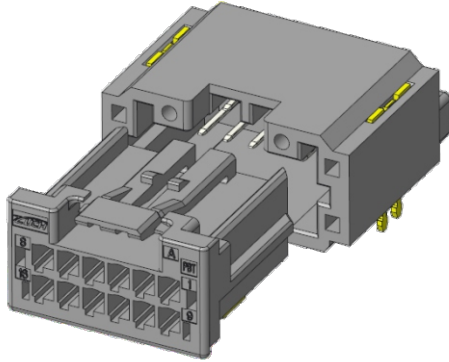

技术参数 (Specification)

额定电流 (Current Rating)	3A
温度范围 (Temperature Range)	-40°C-125°C

TP05001 (13065T-01A-T)



适用电线范围 (Wire Range)	0.30mm ²
材料 (Material)	铜合金 Cu Alloy
材料厚度 (Material Thickness)	0.15mm
最小包装 (MPQ)	10000PCS

AP05001-12Y (13065S-2-12)

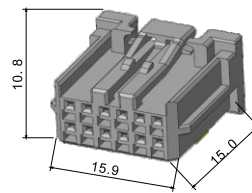

材料 (Material)	PBT
颜色 (Color)	黑色 Black
孔位 (Hole)	12孔
适配端子 (Suitable Terminal)	TP05001
最小包装 (MPQ)	200PCS

AP05001-16Y (13065S-2-16)

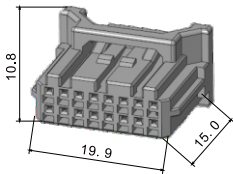

材料 (Material)	PBT
颜色 (Color)	黑色 Black
孔位 (Hole)	16孔
适配端子 (Suitable Terminal)	TP05001
最小包装 (MPQ)	200PCS

AP05001-24Y (13065S-2-24)

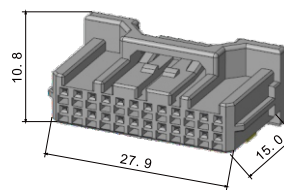

材料 (Material)	PBT
颜色 (Color)	黑色 Black
孔位 (Hole)	24孔
适配端子 (Suitable Terminal)	TP05001
最小包装 (MPQ)	200PCS

AP05001-28Y (13065S-2-28)

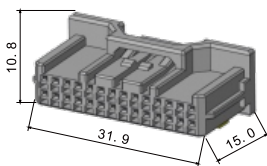

材料 (Material)	PBT
颜色 (Color)	黑色 Black
孔位 (Hole)	28孔
适配端子 (Suitable Terminal)	TP05001
最小包装 (MPQ)	200PCS

AP05001-32Y (13065S-2-32)

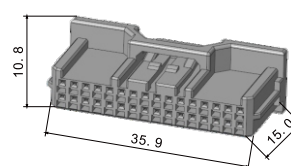

材料 (Material)	PBT
颜色 (Color)	黑色 Black
孔位 (Hole)	32孔
适配端子 (Suitable Terminal)	TP05001
最小包装 (MPQ)	200PCS



0.5mm Series Connector

AP05001-40Y (13065S-2-40)

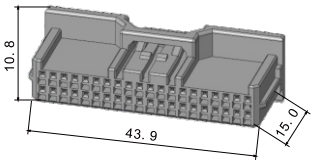

15.0L x 10.8H x 43.9W

材料 (Material)	PPS
颜色 (Color)	黑色 Black
孔位 (Hole)	40孔
适配塑件 (Suitable Housing)	TP05001
最小包装 (MPQ)	200PCS

AW05001-12AWR (13065B-2-12)

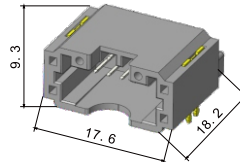

18.2L x 9.3H x 17.6W

材料 (Material)	PPS
颜色 (Color)	黑色 Black
孔位 (Hole)	12孔
适配塑件 (Suitable Housing)	AP05001-12Y
最小包装 (MPQ)	200PCS

AW05001-16AWR (13065B-2-16)

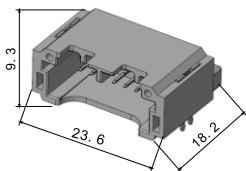

18.2L x 9.3H x 23.6W

材料 (Material)	PPS
颜色 (Color)	黑色 Black
孔位 (Hole)	16孔
适配塑件 (Suitable Housing)	AP05001-16Y
最小包装 (MPQ)	200PCS

AW05001-24AWR (13065B-2-24)

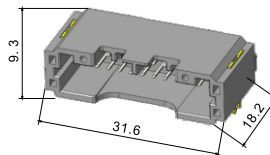

18.2L x 9.3H x 31.6W

材料 (Material)	PPS
颜色 (Color)	黑色 Black
孔位 (Hole)	24孔
适配塑件 (Suitable Housing)	AP05001-24Y
最小包装 (MPQ)	200PCS

AW05001-32AWR (13065B-2-32)

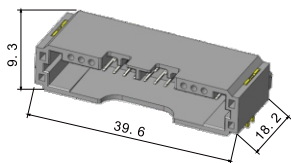

材料 (Material)	PPS
颜色 (Color)	黑色 Black
孔位 (Hole)	32孔
适配塑件 (Suitable Housing)	AP05001-32Y
最小包装 (MPQ)	200PCS

AW05001-40AWR (13065B-2-40)

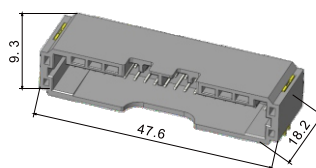

18.2L x 9.3H x 47.6W

材料 (Material)	PPS
颜色 (Color)	黑色 Black
孔位 (Hole)	40孔
适配塑件 (Suitable Housing)	AP05001-40Y
最小包装 (MPQ)	200PCS



0.7mm Series Connector

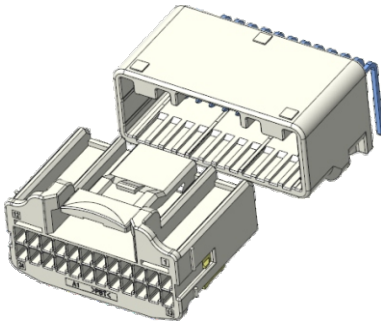

技术参数 (Specification)

额定电流 (Current Rating)	5A
温度范围 (Temperature Range)	-40℃ - 100℃

TP07002 (1123343-1)

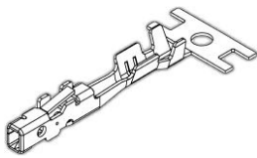

适用电线范围 (Wire Range)	0.30-0.50mm ²
材料 (Material)	铜合金 Cu Alloy
材料厚度 (Material Thickness)	0.25mm
最小包装 (MPQ)	8000PCS

TR07002 (1674742-1)

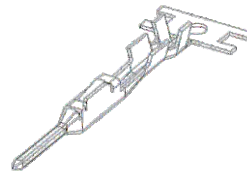

适用电线范围 (Wire Range)	0.30-0.50mm ²
材料 (Material)	铜合金 Cu Alloy
材料厚度 (Material Thickness)	0.25mm
最小包装 (MPQ)	8000PCS

AP07010-10Y

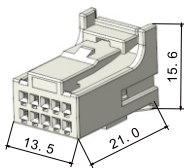

材料 (Material)	PBT
颜色 (Color)	白色 White
孔位 (Hole)	10孔
适配端子 (Suitable Terminal)	TP07002
最小包装 (MPQ)	200PCS

AP07010-12Y (1318774-1)

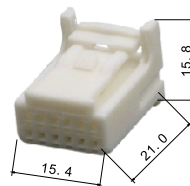

材料 (Material)	PBT
颜色 (Color)	白色 White
孔位 (Hole)	12孔
适配端子 (Suitable Terminal)	TP07002
最小包装 (MPQ)	200PCS

AP07010-16Y (1318386-1)

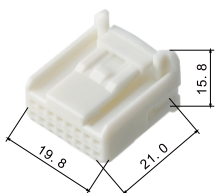

材料 (Material)	PBT
颜色 (Color)	白色 White
孔位 (Hole)	16孔
适配端子 (Suitable Terminal)	TP07002
最小包装 (MPQ)	500PCS

AR07010-16Y (1473410-1)

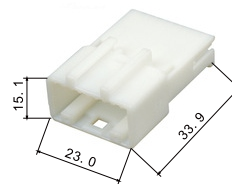

材料 (Material)	PBT
颜色 (Color)	白色 White
孔位 (Hole)	16孔
适配端子 (Suitable Terminal)	TR07002
最小包装 (MPQ)	200PCS



0.7mm Series Connector

AP07010-24Y (1318917-1)

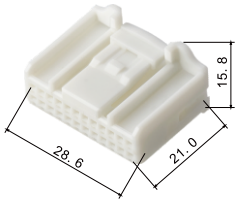

材料 (Material)	PBT
颜色 (Color)	白色 White
孔位 (Hole)	24孔
适配端子 (Suitable Terminal)	TP07002
最小包装 (MPQ)	200PCS

AP07010-32Y (1318747-1)

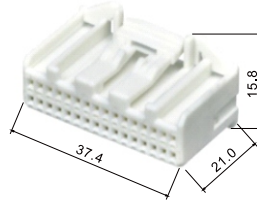

材料 (Material)	PBT
颜色 (Color)	白色 White
孔位 (Hole)	32孔
适配端子 (Suitable Terminal)	TP07002
最小包装 (MPQ)	200PCS

AP07010-40Y (1318389-1)

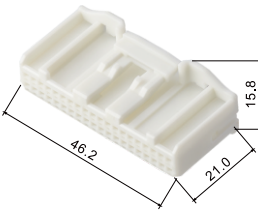

材料 (Material)	PBT
颜色 (Color)	白色 White
孔位 (Hole)	40孔
适配端子 (Suitable Terminal)	TP07002
最小包装 (MPQ)	200PCS

AW07010-12AW (1318772-2)

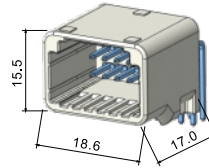

材料 (Material)	PBT
颜色 (Color)	白色 White
孔位 (Hole)	12孔
适配端子 (Suitable Terminal)	/
最小包装 (MPQ)	115PCS

AW07010-16AW (1318382-2)

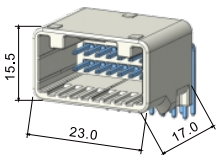

材料 (Material)	PBT
颜色 (Color)	白色 White
孔位 (Hole)	16孔
适配端子 (Suitable Terminal)	/
最小包装 (MPQ)	90PCS

AW07010-24AW (1318853-2)

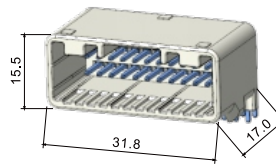

材料 (Material)	PBT
颜色 (Color)	白色 White
孔位 (Hole)	24孔
适配端子 (Suitable Terminal)	/
最小包装 (MPQ)	70PCS

AW07010-32AW (1318745-2)

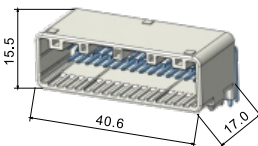

材料 (Material)	PBT
颜色 (Color)	白色 White
孔位 (Hole)	32孔
适配端子 (Suitable Terminal)	/
最小包装 (MPQ)	50PCS

AW07010-40AW (1318384-2)

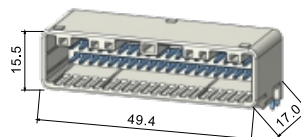

材料 (Material)	PBT
颜色 (Color)	白色 White
孔位 (Hole)	40孔
适配端子 (Suitable Terminal)	/
最小包装 (MPQ)	40PCS



1.5mm Series Connector

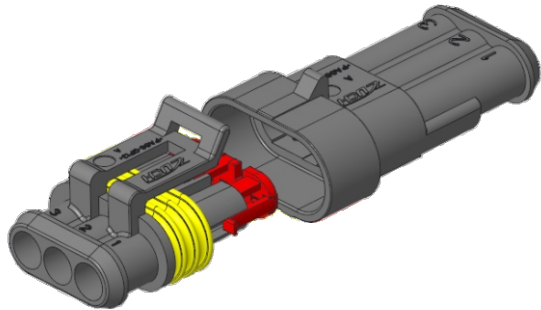

技术参数 (Specification)

额定电流 (Current Rating)	14A
温度范围 (Temperature Range)	-40°C-125°C

TP6002A (282403-1/282110-1/282466-1)



适用电线范围 (Wire Range)	0.30-2.50mm ²
材料 (Material)	铜合金 Cu Alloy
材料厚度 (Material Thickness)	0.30mm
最小包装 (MPQ)	3000PCS

TR6002A (282404-1/282109-1/282465-1)



适用电线范围 (Wire Range)	0.30-2.50mm ²
材料 (Material)	铜合金 Cu Alloy
材料厚度 (Material Thickness)	0.30mm
最小包装 (MPQ)	3000PCS

AP6002A-2Y (282080-1)

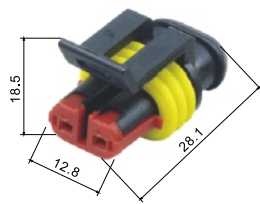

材料 (Material)	PA66
颜色 (Color)	黑色 Black
孔位 (Hole)	2孔
适配端子 (Suitable Terminal)	TP6002A
最小包装 (MPQ)	200PCS

AR6002A-2Y (282103-1)



材料 (Material)	PA66
颜色 (Color)	黑色 Black
孔位 (Hole)	2孔
适配端子 (Suitable Terminal)	TR6002A
最小包装 (MPQ)	200PCS

AP6002A-3Y (282087-1)

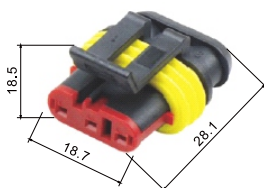

材料 (Material)	PA66
颜色 (Color)	黑色 Black
孔位 (Hole)	3孔
适配端子 (Suitable Terminal)	TP6002A
最小包装 (MPQ)	200PCS

AR6002A-3Y (282105-1)



材料 (Material)	PA66
颜色 (Color)	黑色 Black
孔位 (Hole)	3孔
适配端子 (Suitable Terminal)	TR6002A
最小包装 (MPQ)	200PCS



1.5mm Series Connector

AP6002A-4Y (282088-1)

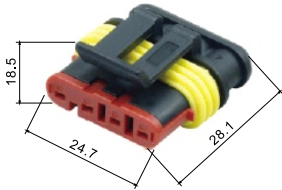

材料 (Material)	PA66
颜色 (Color)	黑色 Black
孔位 (Hole)	4孔
适配端子 (Suitable Terminal)	TP6002A
最小包装 (MPQ)	200PCS

AR6002A-4Y (282106-1)

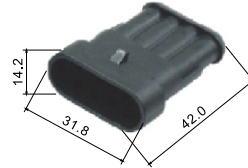

材料 (Material)	PA66
颜色 (Color)	黑色 Black
孔位 (Hole)	4孔
适配端子 (Suitable Terminal)	TR6002A
最小包装 (MPQ)	200PCS

AP6002A-5Y (282089-1)

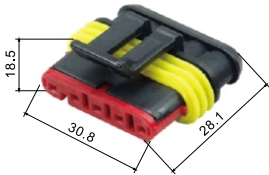

材料 (Material)	PA66
颜色 (Color)	黑色 Black
孔位 (Hole)	5孔
适配端子 (Suitable Terminal)	TP6002A
最小包装 (MPQ)	200PCS

AR6002A-5Y (282107-1)

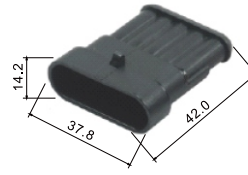

材料 (Material)	PA66
颜色 (Color)	黑色 Black
孔位 (Hole)	5孔
适配端子 (Suitable Terminal)	TR6002A
最小包装 (MPQ)	200PCS

AP6002A-6Y (282890-1)

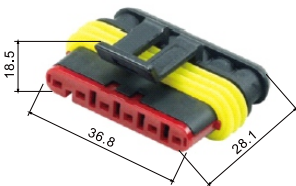

材料 (Material)	PA66
颜色 (Color)	黑色 Black
孔位 (Hole)	6孔
适配端子 (Suitable Terminal)	TP6002A
最小包装 (MPQ)	200PCS

AR6002A-6Y (282108-1)

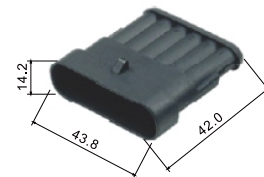

材料 (Material)	PA66
颜色 (Color)	黑色 Black
孔位 (Hole)	6孔
适配端子 (Suitable Terminal)	TR6002A
最小包装 (MPQ)	200PCS



1.6mm Series Connector

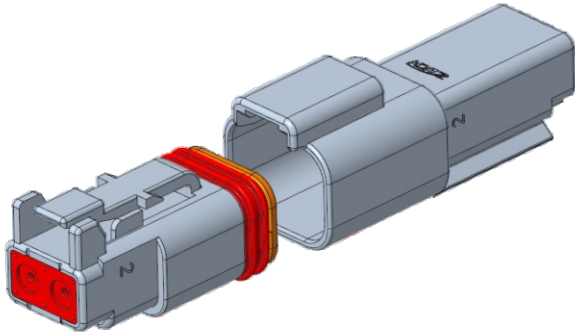

技术参数 (Specification)

额定电流 (Current Rating)	14A
温度范围 (Temperature Range)	-40°C-125°C

TP16001 (1062-16-0122)



适用电线范围 (Wire Range)	1.25-2.00mm ²
材料 (Material)	铜合金 Cu Alloy
材料厚度 (Material Thickness)	0.30mm
最小包装 (MPQ)	2500PCS

TR16001 (1060-16-0122)



适用电线范围 (Wire Range)	1.25-2.00mm ²
材料 (Material)	铜合金 Cu Alloy
材料厚度 (Material Thickness)	0.30mm
最小包装 (MPQ)	2500PCS

AP16001-2Y (DT06-2S)

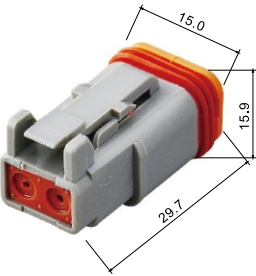

材料 (Material)	PA66
颜色 (Color)	灰色 Gray
孔位 (Hole)	2孔
适配端子 (Suitable Terminal)	TP16001
最小包装 (MPQ)	200PCS

AR16001-2Y (DT04-2P)

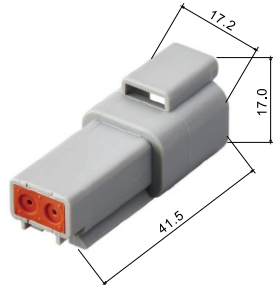

材料 (Material)	PA66
颜色 (Color)	灰色 Gray
孔位 (Hole)	2孔
适配端子 (Suitable Terminal)	TR16001
最小包装 (MPQ)	200PCS

AP16001-3Y (DT06-3S)

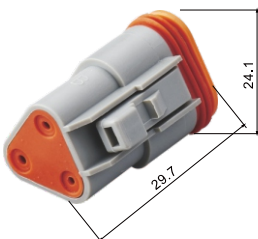

材料 (Material)	PA66
颜色 (Color)	灰色 Gray
孔位 (Hole)	3孔
适配端子 (Suitable Terminal)	TP16001
最小包装 (MPQ)	200PCS

AR16001-3Y (DT04-3P)



材料 (Material)	PA66
颜色 (Color)	灰色 Gray
孔位 (Hole)	3孔
适配端子 (Suitable Terminal)	TR16001
最小包装 (MPQ)	200PCS



Else Series Connector

TP07001 (5-962885-1)

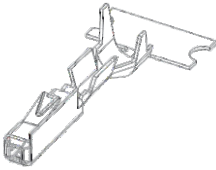

适用电线范围 (Wire Range)	0.30-0.50mm ²
材料 (Material)	铜合金 Cu Alloy
材料厚度 (Material Thickness)	0.25mm
最小包装 (MPQ)	7000PCS

HR07009-2Y (1-968699-1)

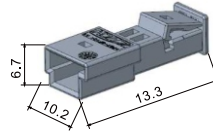

材料 (Material)	PBT
颜色 (Color)	黑色 Black
孔位 (Hole)	2孔
适配端子 (Suitable Terminal)	5-928918-1
最小包装 (MPQ)	200PCS

AP07013-2Y (1-967644-1)

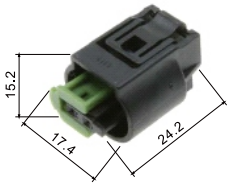

材料 (Material)	PBT
颜色 (Color)	黑色 Black
孔位 (Hole)	2孔
适配端子 (Suitable Terminal)	5-965906-1
最小包装 (MPQ)	200PCS

AP07014-4Y (1-967640-1)

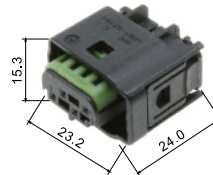

材料 (Material)	PBT
颜色 (Color)	黑色 Black
孔位 (Hole)	4孔
适配端子 (Suitable Terminal)	5-965906-1
最小包装 (MPQ)	200PCS

AP07015-8Y (1-1534229-1)

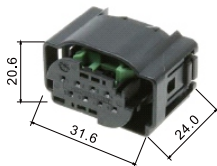

材料 (Material)	PBT
颜色 (Color)	黑色 Black
孔位 (Hole)	8孔
适配端子 (Suitable Terminal)	5-965906-1
最小包装 (MPQ)	200PCS

HP07012-12Y (1-1670990-1)

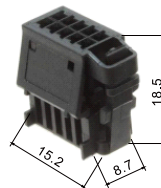

材料 (Material)	PBT
颜色 (Color)	黑色 Black
孔位 (Hole)	10孔
适配端子 (Suitable Terminal)	5-928999-1
最小包装 (MPQ)	200PCS

AP07008-6Y (185311-1/953382-4/953381-1)

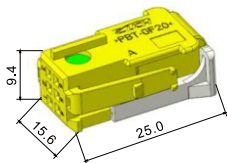

材料 (Material)	PBT
颜色 (Color)	棕色 Brown
孔位 (Hole)	6孔
适配端子 (Suitable Terminal)	5-928999-1
最小包装 (MPQ)	200PCS

HR07012-3Y (953698-1)

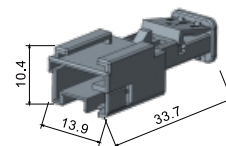

材料 (Material)	PBT
颜色 (Color)	黑色 Black
孔位 (Hole)	3孔
适配端子 (Suitable Terminal)	5-928999-1
最小包装 (MPQ)	200PCS



Else Series Connector

AP10001-2Y (7283-5845)

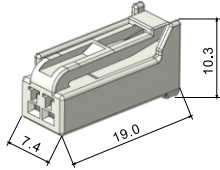

材料 (Material)	PBT
颜色 (Color)	白色 White
孔位 (Hole)	2孔
适配端子 (Suitable Terminal)	7116-4231-02
最小包装 (MPQ)	200PCS

AP12002-3Y (1-1718644-1)

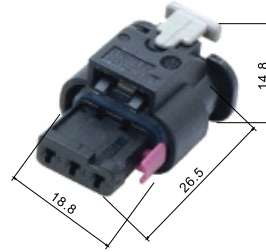

材料 (Material)	PA66
颜色 (Color)	黑色 Black
孔位 (Hole)	3孔
适配端子 (Suitable Terminal)	7-1452665-1
最小包装 (MPQ)	200PCS

AP12003-3Y (1488991-1)

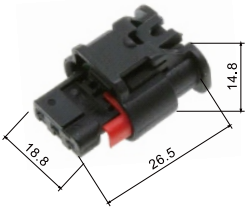

材料 (Material)	PA66
颜色 (Color)	黑色 Black
孔位 (Hole)	3孔
适配端子 (Suitable Terminal)	1418844-1
最小包装 (MPQ)	200PCS

HP28001-10Y (929504-4)

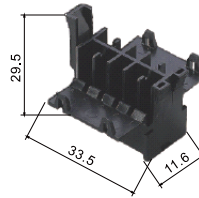

材料 (Material)	PA66
颜色 (Color)	黑色 Black
孔位 (Hole)	10孔
适配端子 (Suitable Terminal)	1-927768-1
最小包装 (MPQ)	200PCS

HP18001-16Y (179631-1)

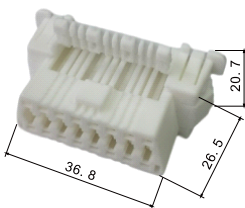

材料 (Material)	PBT
颜色 (Color)	白色 White
孔位 (Hole)	16孔
适配端子 (Suitable Terminal)	776001-1
最小包装 (MPQ)	50PCS

AP15004-20Y (33472-2006)

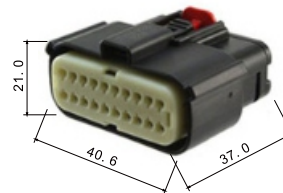

材料 (Material)	PA66
颜色 (Color)	黑色 Black
孔位 (Hole)	20孔
适配端子 (Suitable Terminal)	33012-2003
最小包装 (MPQ)	50PCS

TP18001 (173631-1)



适用电线范围 (Wire Range)	0.50-2.00mm ²
材料 (Material)	铜合金 Cu Alloy
材料厚度 (Material Thickness)	0.25mm
最小包装 (MPQ)	3000PCS

HP18004-12Y (1-173851-1)

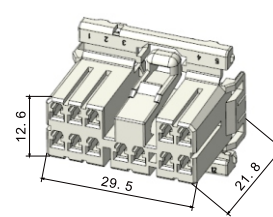

材料 (Material)	PBT
颜色 (Color)	白色 White
孔位 (Hole)	12孔
适配端子 (Suitable Terminal)	TP18001
最小包装 (MPQ)	200PCS



Else Series Connector

TP48001 (8100-1555)

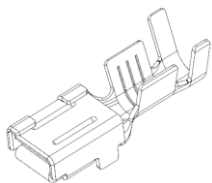

适用电线范围 (Wire Range)	2.00-3.00mm ²
材料 (Material)	磷铜 Phosphorous bronze
材料厚度 (Material Thickness)	0.4mm
最小包装 (MPQ)	1500PCS

TP10001 (8100-1710)



适用电线范围 (Wire Range)	0.30-0.50mm ²
材料 (Material)	磷铜 Phosphorous bronze
材料厚度 (Material Thickness)	0.2mm
最小包装 (MPQ)	5000PCS

APCS007-8Y (6098-2103)

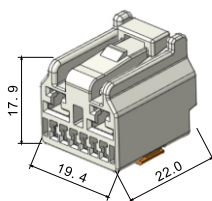

材料 (Material)	PBT
颜色 (Color)	白色 White
孔位 (Hole)	8孔
适配端子 (Suitable Terminal)	TP10001/TP48001
最小包装 (MPQ)	100PCS

APCS008-12Y (284159-1)

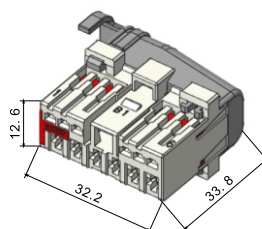

材料 (Material)	PA66
颜色 (Color)	白色 White
孔位 (Hole)	12孔
适配端子 (Suitable Terminal)	965999-2/284087-1
最小包装 (MPQ)	200PCS

APCS008-12Y-01 (284159-3)

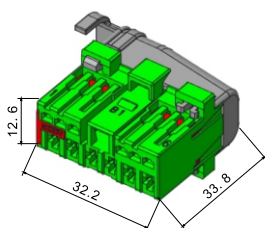

材料 (Material)	PA66
颜色 (Color)	绿色 Green
孔位 (Hole)	12孔
适配端子 (Suitable Terminal)	965999-2/284087-1
最小包装 (MPQ)	50PCS

AR10002-6Y (7282-1172)

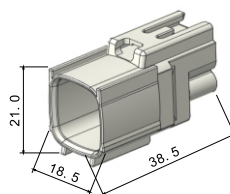

材料 (Material)	PA6T
颜色 (Color)	白色 White
孔位 (Hole)	12孔
适配端子 (Suitable Terminal)	TR10003
最小包装 (MPQ)	200PCS

AP12004-3Y (872-858-541)

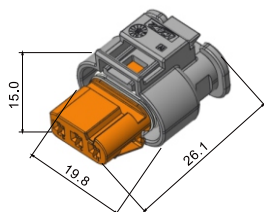

材料 (Material)	PA66
颜色 (Color)	黑色 Black
孔位 (Hole)	3孔
适配端子 (Suitable Terminal)	7-1452668-1
最小包装 (MPQ)	200PCS

AW10001-8A (955-007-001)

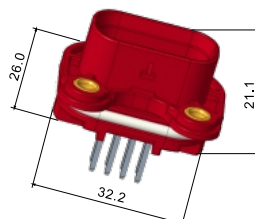

材料 (Material)	PA66
颜色 (Color)	黑色 Black
孔位 (Hole)	8孔
适配端子 (Suitable Terminal)	/
最小包装 (MPQ)	50PCS



Else Series Connector

AW07002-6A (6911-4371)

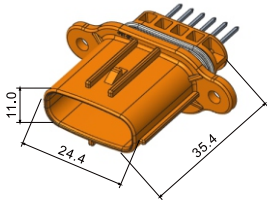

材料 (Material)	PBT
颜色 (Color)	黑色 Black
孔位 (Hole)	6孔
适配端子 (Suitable Terminal)	/
最小包装 (MPQ)	50PCS

AR07016-6Y (6911-4371)

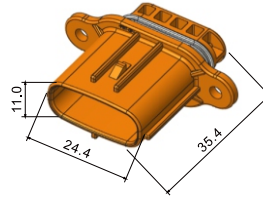

材料 (Material)	PBT
颜色 (Color)	黑色 Black
孔位 (Hole)	6孔
适配端子 (Suitable Terminal)	5-928999-1
最小包装 (MPQ)	200PCS

TP18002 (173631-1)

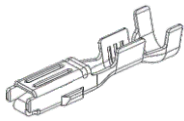

适用电线范围 (Wire Range)	0.50-1.25mm ²
材料 (Material)	铜合金 Cu Alloy
材料厚度 (Material Thickness)	0.3mm
最小包装 (MPQ)	4000PCS

TR18002 (171661-1)

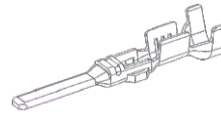

适用电线范围 (Wire Range)	0.50-1.25mm ²
材料 (Material)	铜合金 Cu Alloy
材料厚度 (Material Thickness)	0.3mm
最小包装 (MPQ)	4000PCS

AP18005-12Y (2822638-1)

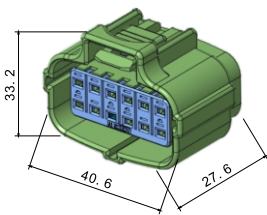

材料 (Material)	PBT
颜色 (Color)	黑色 Black
孔位 (Hole)	12孔
适配端子 (Suitable Terminal)	TP18002
最小包装 (MPQ)	200PCS

AR18005-12Y (174663-2)

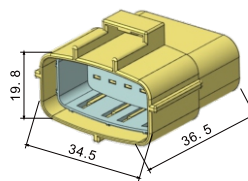

材料 (Material)	PBT
颜色 (Color)	黑色 Black
孔位 (Hole)	12孔
适配端子 (Suitable Terminal)	TR18002
最小包装 (MPQ)	200PCS

AW28001-4AW

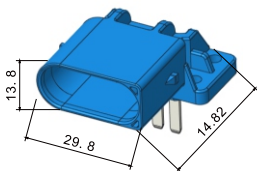

材料 (Material)	PA66
颜色 (Color)	黑色 Black
孔位 (Hole)	4孔
适配端子 (Suitable Terminal)	/
最小包装 (MPQ)	50PCS

AW12001-3AW

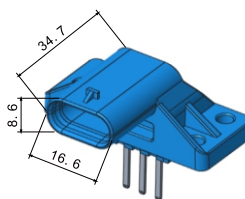

材料 (Material)	PA66
颜色 (Color)	黑色 Black
孔位 (Hole)	3孔
适配端子 (Suitable Terminal)	/
最小包装 (MPQ)	50PCS



Else Series Connector

TP16002 (962875-2)

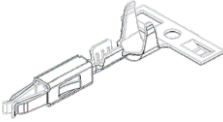

适用电线范围 (Wire Range)	0.25-1.00mm ²
材料 (Material)	铜合金 Cu Alloy
材料厚度 (Material Thickness)	0.3mm
最小包装 (MPQ)	3000PCS

TR16002 (963902-2)



适用电线范围 (Wire Range)	0.25-1.00mm ²
材料 (Material)	铜合金 Cu Alloy
材料厚度 (Material Thickness)	0.3mm
最小包装 (MPQ)	3000PCS

AP28002-4Y (1-1718628-1)



材料 (Material)	PA66
颜色 (Color)	黑色 Black
孔位 (Hole)	4孔
适配端子 (Suitable Terminal)	1-968857-1
最小包装 (MPQ)	100PCS

浙江珠城科技股份有限公司
ZHEJIANG ZUCH TECHNOLOGY CO., LTD.

厂址：浙江省乐清经济开发区纬十五路201号

总机：(86) 577-6283 0888 6283 0887

传真：(86) 577-6284 3118 6120 3118

销售热线：(86) 577-6283 1880 6283 1890

售后服务：(86) 577-6283 0883

国内销售：cnsales@zuch.cn

国际销售：insales@zuch.cn

http: //www.zuch.cn

ADD: No.201,Road wei#15, Yueqing Economic Development Zone,
Yueqing City,Zhejiang Province,China

Tel: (86) 577-6283 0888 6283 0887

Fax: (86) 577-6284 3118 6120 3118

Sales Hotline: (86) 577-6283 1880 6283 1890

After-sales service: (86) 577-6283 0883

Chinese Mainland Marketing: cnsales@zuch.cn

International Marketing: insales@zuch.cn

http: //www.zuch.cn

- 本目录刊载的型号和规格会因产品更新而变化，恕不另行通知。
If the models and specifications in this product catalogue is changed due to the change of products,we will not inform.
- 本目录虽然经多次校对，以求准确，但仅供参考之用，一切以实物及产品说明为准。
This product Catalogue is checked by several times to be correct,but it is only for reference.All is according to products and user Instruction.